



VI^{is}yFit[®]

Invisible mechanism for freedom of expression

Special spring hinge for Injection and Combination frames

VISYFIT®

Invisible mechanism for freedom of expression

Special spring hinge for Injection and Combination frames



COVERED BY
INTERNATIONAL PATENT

FEATURES

PRE-ASSEMBLED
mechanism

HIDDEN HINGE
free expression of design

TWO VERSIONS
with/without front hinge in metal

EASY TO INSERT
into temple, reducing time and costs

NO SCREW / GLUE
needed for fixing

PERFORMANCES

WEAR RESISTANCE
over 50,000 open/close cycles

NO ROCKING
Self Aligning System

PULLING RESISTANCE
(MECHANISM)
> 250 N

PULLING RESISTANCE
(HINGE IN TR90)
> 250 N

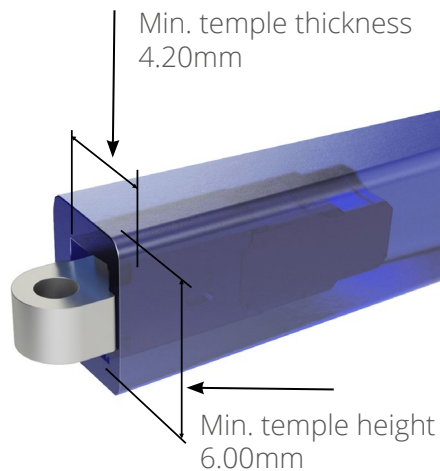

VISYFIT® XL 3.5

Special Spring Hinge for Injection Frames

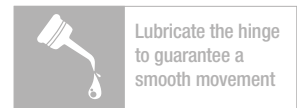

SCREWS

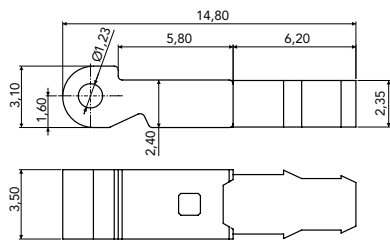

ASSEMBLED HINGE	
SOFT VERSION	03EL21634000
HARD VERSION	03ELC4963A1BNX
Material: Nickel silver	

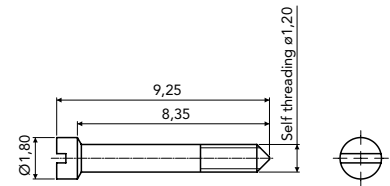

SELF THREADING SCREW	07VI18092500
Material: Stainless steel	

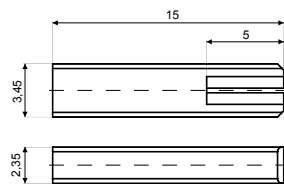

BARRELING CAP	09CAA0363A1WYX
Material: Plastic	

SCREWS

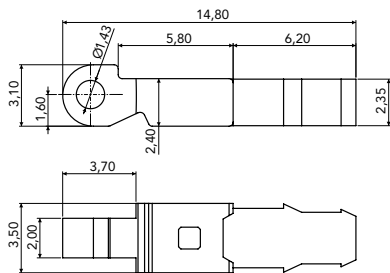

ASSEMBLED HINGE	
SOFT VERSION	03ELA0279A1BNX
HARD VERSION	03ELC4846A1BNX
Material: Nickel silver	

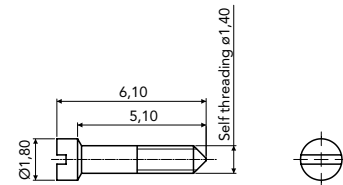

SELF THREADING SCREW	07VIA0366A1BYX
Material: Stainless steel	

Special Spring Hinge for Combination Frames

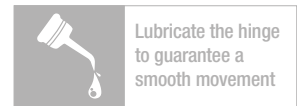

HINGES

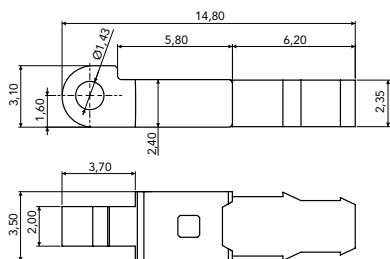

ASSEMBLED HINGE	03ELB1238A1BNX
Material: Nickel silver	

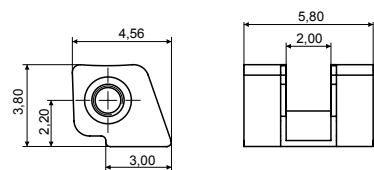

SOLDERING HINGE	03FRC2868A1BY0
Material: Nickel silver	

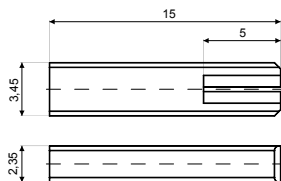

BARRELING CAP	09CAA0363A1WYX
Material: Plastic	

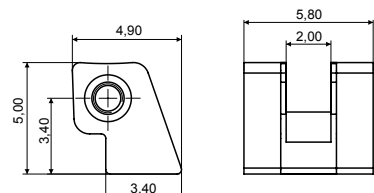

STEP HINGE	03FRC2867A1BY0
Material: Nickel silver	

SCREWS

MINUS SCREW M1.40	
LS	CODE
6.10	07VIC2865A1BYX
Material: Stainless steel	

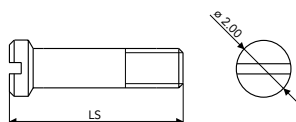

Visottica Industrie S.p.a.
Via Vecchia Trevigiana, 11
31058 Susegana
(Treviso), Italy
Tel +39 0438 6551
Fax +39 0438 450 855
sales@visotticacomotec.com

O'Reilly Industrial Ltd.
Rm 302, Shui Hing Centre,
13 Sheung Yuet Road,
Kowloon Bay, Kowloon, Hong Kong
Tel +852 2796 6010
Fax +852 2796 4631
sales@visotticacomotec.hk

COMOTEC Optical Products (Dongguan) Ltd.
No. 20, Weijian Road,
Weijian Industrial Park,
ChaShan Town, Dongguan City
Guangdong Province, China 523380
Tel +86 769 8233 9955
Fax +86 769 8233 9977